

Makura hambakaitsmed

kasutusjuhendid

Sisukord

Ignis Convertible	3
Lithos Convertible	5
Tephra Max Convertible	7
Toka Convertible	9
Ignis Pro	11
Kyro Pro	13
Lithos Pro	15
Tephra Max	17
Toka Pro	19

FITTING INSTRUCTIONS

You will need: A pan filled with 3cm water, an oven mitt, a slotted spoon, 1 cup of iced water, a mirror and a timer.

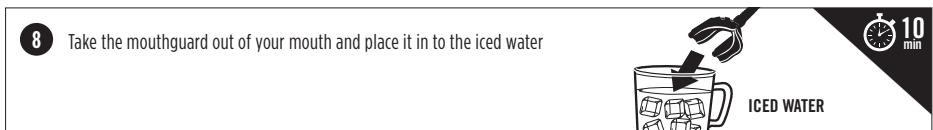
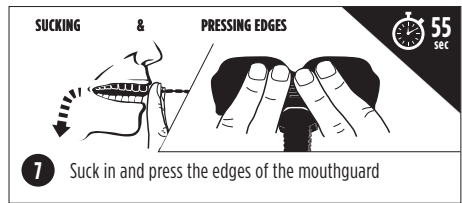
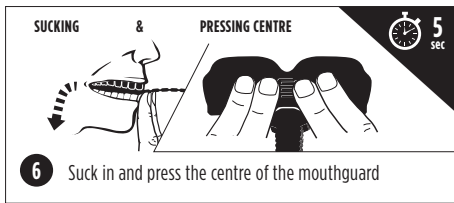
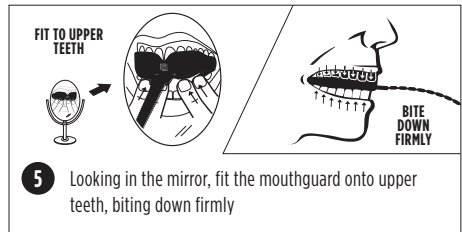
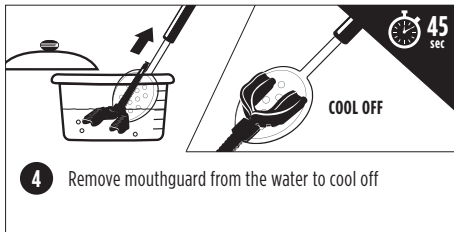
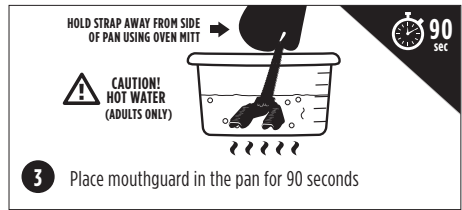
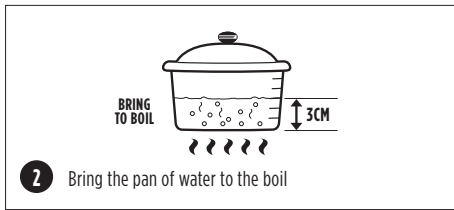
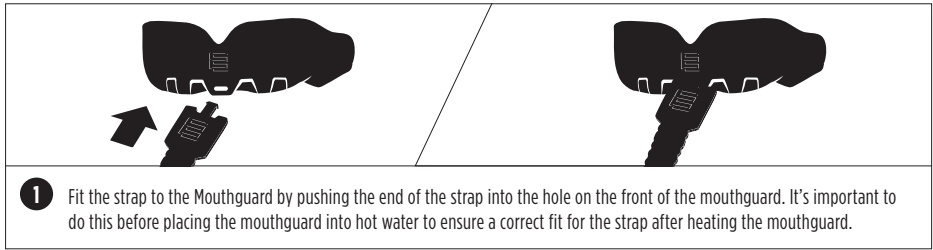

- 9** Place the mouthguard in the mouth and test for a secure, comfortable fit.
- 10** If mouthguard does not fit comfortably, or does not stay in place **A** a suitably-fitted mouthguard should withstand hanging a 100g weight off it for at least 30 seconds without falling out), allow a few minutes to rest before repeating procedures 1-8 (procedures 6 and 7 are the most important steps).
- 11** Only if necessary, **B** carefully use a pair of scissors to trim off small pieces.
- 12** Attach the mouthguard strap to your helmet by threading the open end of the strap over the bottom bar of the helmet grill and then back underneath, before fixing the end inside the groove in the middle of the strap.

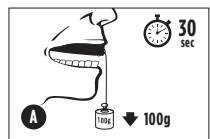

Do not throw this leaflet away as it contains information that is important to the user.

WARNING!

Please ensure that you have read and fully understood the following safety precautions and user guide before using this mouthguard:

This mouthguard is not for use with braces. DO NOT chew your mouthguard.

To ensure that your mouthguard functions correctly it is essential that it is adjusted to fit your teeth and gums properly. If your mouthguard is chewed and/or is not used as intended, then its effectiveness in terms of fit, protection and durability will be greatly reduced. Please carefully follow the fitting instructions overleaf. The intended user of this Ignis Convertible mouthguard must ensure that they add their name to the label located inside the mouthguard box and in the area provided below in the Mouthguard User Guide.

This Mouthguard must not be used by any person other than the named person detailed in the Mouthguard User Guide and on the Mouthguard Box.

As per Item 4 of the Fitting Instructions overleaf, please ensure that the Mouthguard has cooled sufficiently (45 seconds) prior to placing the Mouthguard in your mouth.

For wearers whose jaw is still in growth, primary dentition exfoliation and secondary dentition eruption, the fit of the mouthguard must be checked regularly by a responsible guardian. If the mouthguard is found to be loose or tight fitting, to the teeth or gums, it must be replaced.

MOUTHGUARD USER GUIDE

- This packaging contains important information and must be retained for future reference.
- This Ignis Convertible (Type 2 Mouth - Adapted Mouthguard) has passed SATRA Document M33:2011 – Issue 3, Performance Level 2 impact tests for people playing lesser contact sports and recreations such as Baseball, Basketball, Cricket, Football, Hockey, Lacrosse, Martial Arts, Rugby and other contact sports.
- There are three levels of the Impact Performance Level allocated to Mouthguards, namely 1, 2 and 3, where Level 1 offers the lowest level of protection and Level 3 offers the highest level of protection.
- When choosing a mouthguard please select a mouthguard of appropriate size and type based on the age range information provided by the manufacturer. Please ensure that the mouthguard you have chosen is of the correct type and performance level related to the sport and recreation that you will be using the mouthguard for. A list of all the sporting activities that this mouthguard is intended to be suitable for is provided.
- This mouthguard is not for use with braces, consult a dentist or orthodontist fitting a brace or other device to the teeth concerning the suitability of this mouthguard, this mouthguard should not be used unless approved by the person fitting the brace.
- For full details of fitting, please see Fitting Instructions overleaf.
- For those whose jaw is still growing, the fitting of the mouthguard should be checked regularly. The mouthguard will need to be replaced if it no longer fits properly.
- Please consult your dental surgeon or orthodontist before use if you intend to use this mouthguard as a night guard.
- This mouthguard is made from FDA grades of TPR and EVA.
- The Box supplied provides secure, clean storage for your mouthguard. The Mouthguard should be kept in the box when not in use. Use fresh water (do not exceed 35°C/95°F) to wash both mouthguard and case after each use. Dry thoroughly before storage.
- This Ignis Convertible Mouthguard is for the sole use of _____ From the following date / /
- Dependent upon the regularity and severity of use, Makura Sport recommends that your mouthguard should be replaced every 2 years, however you must visually check your mouthguard after each use. If the biting surface is worn, cracked or split the mouthguard should be replaced immediately.
- If the mouthguard causes sensitization or allergic reaction, or if you experience discomfort after wearing your mouthguard, medical attention should be sought immediately.
- This Type 2 mouth-adapted mouthguard has been tested and certified by SATRA Technology Centre Ltd, Wyndham Way, Telford Way Industrial Estate Kettering, Northamptonshire NN 16 8SD, United Kingdom (Notified Body Number 0321).



This mouthguard does not contain Latex. The materials used are not currently known to cause allergic reactions or sensitization.

FITTING INSTRUCTIONS

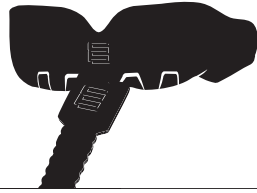
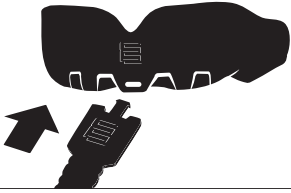

- 1 Fit the strap to the Mouthguard by pushing the end of the strap into the hole on the front of the mouthguard.

- 2 There is no boiling or custom fitting required with this Lithos Convertible mouthguard. Place mouthguard in your mouth and carefully fit over the fixed braces ensuring the braces align with the Ortho Channel. This mouthguard will fit securely and comfortably when properly positioned.

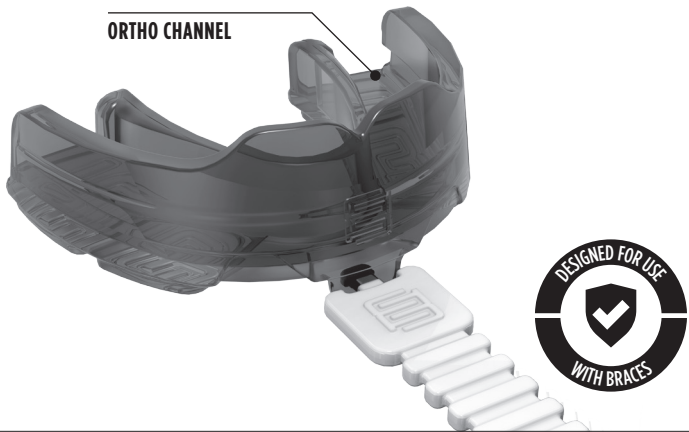

- 3 Take care when removing mouthguard so as not to dislodge braces.
- 4 This Lithos Convertible mouthguard does not require any 'finishing', i.e. no trimming is permitted to assist with fit and comfort.

- 5 Attach the mouthguard strap to your helmet by threading the open end of the strap over the bottom bar of the helmet grill and then back underneath, before fixing the end inside the groove in the middle of the strap.



Do not throw this leaflet away as it contains information that is important to the user.

WARNING!

Please ensure that you have read and fully understood the following safety precautions and user guide before using this mouthguard:

This mouthguard is suitable for use with braces, consult a dentist or orthodontist fitting a brace or other device to the teeth concerning the suitability of this mouthguard, this mouthguard should not be used unless approved by the person fitting the brace.

DO NOT chew your mouthguard.

If your mouthguard is chewed and/or is not used as intended, then its effectiveness in terms of fit, protection and durability will be greatly reduced. Please carefully follow the fitting instructions overleaf. The intended user of this Lithos Convertible mouthguard must ensure that they add their name to the label located inside the mouthguard box and in the area provided below in the Mouthguard User Guide.

This Mouthguard must not be used by any person other than the named person detailed in the Mouthguard User Guide and on the Mouthguard Box

For wearers whose jaw is still in growth, primary dentition exfoliation and secondary dentition eruption, the fit of the mouthguard must be checked regularly by a responsible guardian. If the mouthguard is found to be loose or tight fitting, to the teeth or gums, it must be replaced.

MOUTHGUARD USER GUIDE

- **This mouthguard is suitable for use with braces, consult a dentist or orthodontist fitting a brace or other device to the teeth concerning the suitability of this mouthguard, this mouthguard should not be used unless approved by the person fitting the brace.**
- This packaging contains important information and must be retained for future reference.
- This Lithos Convertible (Ready-Made Type Mouthguard) has passed DD 253: 2001 and achieved Performance Level 2 impact tests for people playing lesser contact sports and recreations such as Baseball, Basketball, Cricket, Football, Hockey, Lacrosse, Martial Arts, Rugby and other contact sports.
- There are two levels of the Impact Performance Level allocated to DD 253: 2001 approved Mouthguards, namely 1 and 2, where Level 1 offers the lowest level of protection and Level 2 offers the highest level of protection.
- When choosing a mouthguard please select a mouthguard of appropriate size and type based on the age range information provided by the manufacturer. Please ensure that the mouthguard you have chosen is of the correct type and performance level related to the sport and recreation that you will be using the mouthguard for. A list of all the sporting activities that this mouthguard is intended to be suitable for is provided.
- For full details of fitting, please see Fitting Instructions overleaf.
- For those whose jaw is still growing, the fitting of the mouthguard should be checked regularly. The mouthguard will need to be replaced if it no longer fits properly.
- Please consult your dental surgeon or orthodontist before use if you intend to use this mouthguard as a night guard.
- This mouthguard is made from a medical grade Silicone Rubber.
- The Box supplied provides secure, clean storage for your mouthguard. The Mouthguard should be kept in the box when not in use. Use fresh water (do not exceed 35°C/95°F) to wash both mouthguard and case after each use. Dry thoroughly before storage.
- This Lithos Convertible Mouthguard is for the sole use of _____ From the following date / /
- Dependent upon the regularity and severity of use, Makura Sport recommends that your mouthguard should be replaced every 2 years, however you must visually check your mouthguard after each use. If the biting surface is worn, cracked or split the mouthguard should be replaced immediately.
- If the mouthguard causes sensitization or allergic reaction, or if you experience discomfort after wearing your mouthguard, medical attention should be sought immediately.
- This Ready-Made Type mouthguard has been tested and certified by SATRA Technology Centre Ltd, Wyndham Way, Telford Way Industrial Estate, Kettering, Northamptonshire NN 16 8SD, United Kingdom (Notified Body Number 0321).

This mouthguard does not contain Latex. The materials used are not currently known to cause allergic reactions or sensitization.

FITTING INSTRUCTIONS

You will need: A pan filled with 3cm water, an oven mitt, a slotted spoon, 1 cup of iced water, a mirror and a timer.

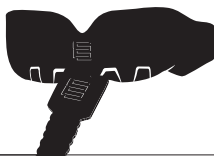
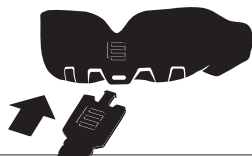

- 1 Fit the strap to the Mouthguard by pushing the end of the strap into the hole on the front of the mouthguard. It's important to do this before placing the mouthguard into hot water to ensure a correct fit for the strap after heating the mouthguard.

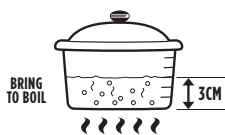

- 2 Bring the pan of water to the boil

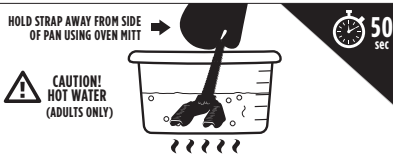

- 3 Place mouthguard in the pan for 50 seconds



- 4 Remove mouthguard from the water to cool off



- 5 Looking in the mirror, fit the mouthguard onto upper teeth, biting down firmly



- 6 Suck in and press the centre of the mouthguard

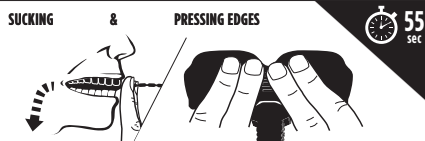

- 7 Suck in and press the edges of the mouthguard

- 8 Take the mouthguard out of your mouth and place it in to the iced water



- 9 Place the mouthguard in the mouth and test for a secure, comfortable fit.

- 10 If mouthguard does not fit comfortably, or does not stay in place (A) a suitably-fitted mouthguard should withstand hanging a 100g weight off it for at least 30 seconds without falling out), allow a few minutes to rest before repeating procedures 1-8 (procedures 6 and 7 are the most important steps).

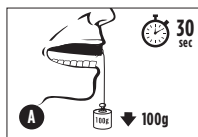

- 11 Only if necessary, (B) carefully use a pair of scissors to trim off small pieces.



- 12 Attach the mouthguard strap to your helmet by threading the open end of the strap over the bottom bar of the helmet grill and then back underneath, before fixing the end inside the groove in the middle of the strap.



Do not throw this leaflet away as it contains information that is important to the user.

WARNING!

Please ensure that you have read and fully understood the following safety precautions and user guide before using this mouthguard:

This mouthguard is not for use with braces. DO NOT chew your mouthguard.

To ensure that your mouthguard functions correctly it is essential that it is adjusted to fit your teeth and gums properly. If your mouthguard is chewed and/or is not used as intended, then its effectiveness in terms of fit, protection and durability will be greatly reduced. Please carefully follow the fitting instructions overleaf. The intended user of this Tephra Max Convertible mouthguard must ensure that they add their name to the label located inside the mouthguard box and in the area provided below in the Mouthguard User Guide.

This Mouthguard must not be used by any person other than the named person detailed in the Mouthguard User Guide and on the Mouthguard Box.

As per Item 4 of the Fitting Instructions overleaf, please ensure that the Mouthguard has cooled sufficiently (90 seconds) prior to placing the Mouthguard in your mouth.

For wearers whose jaw is still in growth, primary dentition exfoliation and secondary dentition eruption, the fit of the mouthguard must be checked regularly by a responsible guardian. If the mouthguard is found to be loose or tight fitting, to the teeth or gums, it must be replaced.

MOUTHGUARD USER GUIDE

- This packaging contains important information and must be retained for future reference.
- This Tephra Max Convertible (Type 2 Mouth - Adapted Mouthguard) has passed SATRA Document M33:2011 – Issue 3, Performance Level 3 impact tests for people playing lesser contact sports and recreations such as Baseball, Basketball, Cricket, Football, Hockey, Lacrosse, Martial Arts, Rugby and other contact sports.
- There are three levels of the Impact Performance Level allocated to Mouthguards, namely 1, 2 and 3, where Level 1 offers the lowest level of protection and Level 3 offers the highest level of protection.
- When choosing a mouthguard please select a mouthguard of appropriate size and type based on the age range information provided by the manufacturer. Please ensure that the mouthguard you have chosen is of the correct type and performance level related to the sport and recreation that you will be using the mouthguard for. A list of all the sporting activities that this mouthguard is intended to be suitable for is provided.
- This mouthguard is not for use with braces, consult a dentist or orthodontist fitting a brace or other device to the teeth concerning the suitability of this mouthguard, this mouthguard should not be used unless approved by the person fitting the brace.
- For full details of fitting, please see Fitting Instructions overleaf.
- For those whose jaw is still growing, the fitting of the mouthguard should be checked regularly. The mouthguard will need to be replaced if it no longer fits properly.
- Please consult your dental surgeon or orthodontist before use if you intend to use this mouthguard as a night guard.
- This mouthguard is made from FDA grades of TPR and EVA.
- The Box supplied provides secure, clean storage for your mouthguard. The Mouthguard should be kept in the box when not in use. Use fresh water (do not exceed 35°C/95°F) to wash both mouthguard and case after each use. Dry thoroughly before storage.
- This Tephra Max Convertible Mouthguard is for the sole use of _____ From the following date / /
- Dependent upon the regularity and severity of use, Makura Sport recommends that your mouthguard should be replaced every 2 years, however you must visually check your mouthguard after each use. If the biting surface is worn, cracked or split the mouthguard should be replaced immediately.
- If the mouthguard causes sensitization or allergic reaction, or if you experience discomfort after wearing your mouthguard, medical attention should be sought immediately.
- This Type 2 mouth-adapted mouthguard has been tested and certified by SATRA Technology Centre Ltd, Wyndham Way, Telford Way Industrial Estate Kettering, Northamptonshire NN 16 8SD, United Kingdom (Notified Body Number 0321).



This mouthguard does not contain Latex. The materials used are not currently known to cause allergic reactions or sensitization.

FITTING INSTRUCTIONS

You will need: A pan filled with 3cm water, an oven mitt, a slotted spoon, 1 cup of iced water, a mirror and a timer.

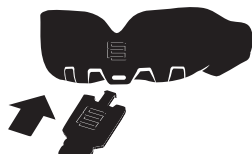

- 1** Fit the strap to the Mouthguard by pushing the end of the strap into the hole on the front of the mouthguard. It's important to do this before placing the mouthguard into hot water to ensure a correct fit for the strap after heating the mouthguard.

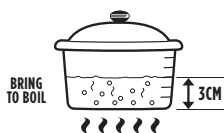

- 2** Bring the pan of water to the boil



- 3** Place mouthguard in the pan for 12 seconds

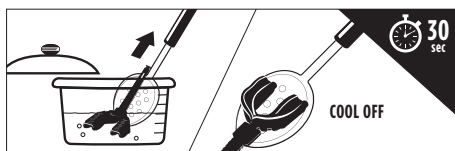

- 4** Remove mouthguard from the water to cool off



- 5** Looking in the mirror, fit the mouthguard onto upper teeth, biting down firmly



- 6** Suck in and press the centre of the mouthguard

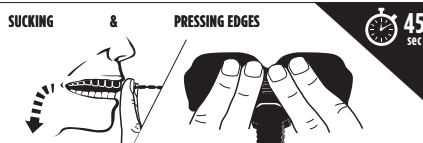

- 7** Suck in and press the edges of the mouthguard

- 8** Take the mouthguard out of your mouth and place it in to the iced water



- 9** Place the mouthguard in the mouth and test for a secure, comfortable fit.

- 10** If mouthguard does not fit comfortably, or does not stay in place **A** a suitably-fitted mouthguard should withstand hanging a 100g weight off it for at least 30 seconds without falling out), allow a few minutes to rest before repeating procedures 1-8 (procedures 6 and 7 are the most important steps).

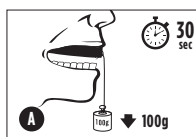

- 11** Only if necessary, **B** carefully use a pair of scissors to trim off small pieces.



- 12** Attach the mouthguard strap to your helmet by threading the open end of the strap over the bottom bar of the helmet grill and then back underneath, before fixing the end inside the groove in the middle of the strap.



Do not throw this leaflet away as it contains information that is important to the user.

WARNING!

Please ensure that you have read and fully understood the following safety precautions and user guide before using this mouthguard:

This mouthguard is not for use with braces. DO NOT chew your mouthguard.

To ensure that your mouthguard functions correctly it is essential that it is adjusted to fit your teeth and gums properly. If your mouthguard is chewed and/or is not used as intended, then its effectiveness in terms of fit, protection and durability will be greatly reduced. Please carefully follow the fitting instructions overleaf. The intended user of this Toka Convertible mouthguard must ensure that they add their name to the label located inside the mouthguard box and in the area provided below in the Mouthguard User Guide.

This Mouthguard must not be used by any person other than the named person detailed in the Mouthguard User Guide and on the Mouthguard Box.

As per Item 4 of the Fitting Instructions overleaf, please ensure that the Mouthguard has cooled sufficiently (30 seconds) prior to placing the Mouthguard in your mouth.

For wearers whose jaw is still in growth, primary dentition exfoliation and secondary dentition eruption, the fit of the mouthguard must be checked regularly by a responsible guardian. If the mouthguard is found to be loose or tight fitting, to the teeth or gums, it must be replaced.

MOUTHGUARD USER GUIDE

- This packaging contains important information and must be retained for future reference.
- This Toka Convertible (Type 2 Mouth - Adapted Mouthguard) has passed SATRA Document M33:2011 – Issue 3, Performance Level 2 impact tests for people playing lesser contact sports and recreations such as Baseball, Basketball, Cricket, Football, Hockey, Lacrosse, Martial Arts, Rugby and other contact sports.
- There are three levels of the Impact Performance Level allocated to Mouthguards, namely 1, 2 and 3, where Level 1 offers the lowest level of protection and Level 3 offers the highest level of protection.
- When choosing a mouthguard please select a mouthguard of appropriate size and type based on the age range information provided by the manufacturer. Please ensure that the mouthguard you have chosen is of the correct type and performance level related to the sport and recreation that you will be using the mouthguard for. A list of all the sporting activities that this mouthguard is intended to be suitable for is provided.
- This mouthguard is not for use with braces, consult a dentist or orthodontist fitting a brace or other device to the teeth concerning the suitability of this mouthguard, this mouthguard should not be used unless approved by the person fitting the brace.
- For full details of fitting, please see Fitting Instructions overleaf.
- For those whose jaw is still growing, the fitting of the mouthguard should be checked regularly. The mouthguard will need to be replaced if it no longer fits properly.
- Please consult your dental surgeon or orthodontist before use if you intend to use this mouthguard as a night guard.
- This mouthguard is made from FDA grades of TPR and EVA.
- The Box supplied provides secure, clean storage for your mouthguard. The Mouthguard should be kept in the box when not in use. Use fresh water (do not exceed 35°C/95°F) to wash both mouthguard and case after each use. Dry thoroughly before storage.
- This Toka Convertible Mouthguard is for the sole use of _____ From the following date / /
- Dependent upon the regularity and severity of use, Makura Sport recommends that your mouthguard should be replaced every 2 years, however you must visually check your mouthguard after each use. If the biting surface is worn, cracked or split the mouthguard should be replaced immediately.
- If the mouthguard causes sensitization or allergic reaction, or if you experience discomfort after wearing your mouthguard, medical attention should be sought immediately.
- This Type 2 mouth-adapted mouthguard has been tested and certified by SATRA Technology Centre Ltd, Wyndham Way, Telford Way Industrial Estate Kettering, Northamptonshire NN 16 8SD, United Kingdom (Notified Body Number 0321).



This mouthguard does not contain Latex. The materials used are not currently known to cause allergic reactions or sensitization.

FITTING INSTRUCTIONS

You will need: 1 pan filled with 3cm water, 1 slotted spoon, 1 cup of iced water, 1 mirror and a timer.

BRING TO BOIL

3CM

1 Bring the pan of water to the boil

CAUTION! HOT WATER
ADULTS ONLY

90 sec

2 Place mouthguard in the pan for 90 seconds

COOL OFF

45 sec

3 Remove mouthguard from the water to cool off

FIT TO UPPER TEETH

BITE DOWN FIRMLY

4 Looking in the mirror, fit the mouthguard onto upper teeth, biting down firmly

SUCKING & PRESSING CENTRE

5 sec

5 Suck in and press the centre of the mouthguard

SUCKING & PRESSING EDGES

55 sec

6 Suck in and press the edges of the mouthguard

ICED WATER

10 min

7 Take the mouthguard out of your mouth and place it in to the iced water

8 Place the mouthguard in the mouth and test for a secure, comfortable fit.

9 If mouthguard does not fit comfortably, or does not stay in place **A** a suitably-fitted mouthguard should withstand hanging a 100g weight off it for at least 30 seconds without falling out), allow a few minutes to rest before repeating procedures 1-7 (procedures 5 and 6 are the most important steps).

A

100g

30 sec

10 Only if necessary, **B** carefully use a pair of scissors to trim off small pieces.

B

SCISSORS ONLY

Do not throw this leaflet away as it contains information that is important to the user

WARNING!

Please ensure that you have read and fully understood the following safety precautions and user guide before using this mouthguard:

This mouthguard is not for use with braces. DO NOT chew your mouthguard.

To ensure that your mouthguard functions correctly it is essential that it is adjusted to fit your teeth and gums properly. If your mouthguard is chewed and/or is not used as intended, then its effectiveness in terms of fit, protection and durability will be greatly reduced. Please carefully follow the fitting instructions overleaf. The intended user of this Ignis Pro mouthguard must ensure that they add their name to the label located inside the mouthguard box and in the area provided below in the Mouthguard User Guide.

This Mouthguard must not be used by any person other than the named person detailed in the Mouthguard User Guide and on the Mouthguard Box.

As per Item 3 of the Fitting Instructions overleaf, please ensure that the Mouthguard has cooled sufficiently (45 seconds) prior to placing the Mouthguard in your mouth.

For wearers whose jaw is still in growth, primary dentition exfoliation and secondary dentition eruption, the fit of the mouthguard must be checked regularly by a responsible guardian. If the mouthguard is found to be loose or tight fitting, to the teeth or gums, it must be replaced.

MOUTHGUARD USER GUIDE

- This packaging contains important information and must be retained for future reference.
- This Ignis Pro (Type 2 Mouth - Adapted Mouthguard) has passed SATRA Document M33:2011 – Issue 3, Performance Level 2 impact tests for people playing lesser contact sports and recreations such as Baseball, Basketball, Cricket, Football, Hockey, Lacrosse, Martial Arts, Rugby and other contact sports.
- There are three levels of the Impact Performance Level allocated to Mouthguards, namely 1, 2 and 3, where Level 1 offers the lowest level of protection and Level 3 offers the highest level of protection.
- When choosing a mouthguard please select a mouthguard of appropriate size and type based on the age range information provided by the manufacturer. Please ensure that the mouthguard you have chosen is of the correct type and performance level related to the sport and recreation that you will be using the mouthguard for. A list of all the sporting activities that this mouthguard is intended to be suitable for is provided.
- This mouthguard is not for use with braces, consult a dentist or orthodontist fitting a brace or other device to the teeth concerning the suitability of this mouthguard, this mouthguard should not be used unless approved by the person fitting the brace.
- For full details of fitting, please see Fitting Instructions overleaf.
- For those whose jaw is still growing, the fitting of the mouthguard should be checked regularly. The mouthguard will need to be replaced if it no longer fits properly.
- Please consult your dental surgeon or orthodontist before use if you intend to use this mouthguard as a night guard.
- This mouthguard is made from FDA grades of TPR and EVA.
- The Box supplied provides secure, clean storage for your mouthguard. The Mouthguard should be kept in the box when not in use. Use fresh water (do not exceed 35°C/95°F) to wash both mouthguard and case after each use. Dry thoroughly before storage.
- This Ignis Pro Mouthguard is for the sole use of _____ From the following date / /
- Dependent upon the regularity and severity of use, Makura Sport recommends that your mouthguard should be replaced every 2 years, however you must visually check your mouthguard after each use. If the biting surface is worn, cracked or split the mouthguard should be replaced immediately.
- If the mouthguard causes sensitization or allergic reaction, or if you experience discomfort after wearing your mouthguard, medical attention should be sought immediately.
- This Type 2 mouth-adapted mouthguard has been tested and certified by SATRA Technology Centre Ltd, Wyndham Way, Telford Way Industrial Estate Kettering, Northamptonshire NN 16 8SD, United Kingdom (Notified Body Number 0321).



This mouthguard does not contain Latex. The materials used are not currently known to cause allergic reactions or sensitization.

FITTING INSTRUCTIONS

You will need: 1 pan filled with 3cm water, 1 slotted spoon, 1 cup of iced water, 1 mirror and a timer.

BRING TO BOIL

1 Bring the pan of water to the boil

CAUTION! HOT WATER
ADULTS ONLY

2 Place mouthguard in the pan for 12 seconds

12 sec

COOL OFF

3 Remove mouthguard from the water to cool off

20 sec

FIT TO UPPER TEETH

4 Looking in the mirror, fit the mouthguard onto upper teeth, biting down firmly

BITE DOWN FIRMLY

SUCKING & PRESSING CENTRE

5 Suck in and press the centre of the mouthguard

5 sec

SUCKING & PRESSING EDGES

6 Suck in and press the edges of the mouthguard

55 sec

7 Take the mouthguard out of your mouth and place it in to the iced water

ICED WATER

10 min

8 Place the mouthguard in the mouth and test for a secure, comfortable fit.

9 If mouthguard does not fit comfortably, or does not stay in place **A** a suitably-fitted mouthguard should withstand hanging a 100g weight off it for at least 30 seconds without falling out), allow a few minutes to rest before repeating procedures 1-7 (procedures 5 and 6 are the most important steps).

A

100g

30 sec

10 Only if necessary, **B** carefully use a pair of scissors to trim off small pieces.

B

SCISSORS ONLY

Do not throw this leaflet away as it contains information that is important to the user

WARNING!

Please ensure that you have read and fully understood the following safety precautions and user guide before using this mouthguard:

This mouthguard is not for use with braces. DO NOT chew your mouthguard.

To ensure that your mouthguard functions correctly it is essential that it is adjusted to fit your teeth and gums properly. If your mouthguard is chewed and/or is not used as intended, then its effectiveness in terms of fit, protection and durability will be greatly reduced. Please carefully follow the fitting instructions overleaf. The intended user of this Kyro Pro mouthguard must ensure that they add their name to the label located inside the mouthguard box and in the area provided below in the Mouthguard User Guide.

This Mouthguard must not be used by any person other than the named person detailed in the Mouthguard User Guide and on the Mouthguard Box.

As per Item 3 of the Fitting Instructions overleaf, please ensure that the Mouthguard has cooled sufficiently (20 seconds) prior to placing the Mouthguard in your mouth.

For wearers whose jaw is still in growth, primary dentition exfoliation and secondary dentition eruption, the fit of the mouthguard must be checked regularly by a responsible guardian. If the mouthguard is found to be loose or tight fitting, to the teeth or gums, it must be replaced.

MOUTHGUARD USER GUIDE

- This packaging contains important information and must be retained for future reference.
- This Kyro Pro (Type 2 Mouth - Adapted Mouthguard) has passed SATRA Document M33:2011 – Issue 3, Performance Level 1 impact tests for people playing lesser contact sports and recreations such as Baseball, Basketball, Cricket, Football, Hockey, Lacrosse, Martial Arts, Rugby and other contact sports.
- There are three levels of the Impact Performance Level allocated to Mouthguards, namely 1, 2 and 3, where Level 1 offers the lowest level of protection and Level 3 offers the highest level of protection.
- When choosing a mouthguard please select a mouthguard of appropriate size and type based on the age range information provided by the manufacturer. Please ensure that the mouthguard you have chosen is of the correct type and performance level related to the sport and recreation that you will be using the mouthguard for. A list of all the sporting activities that this mouthguard is intended to be suitable for is provided.
- This mouthguard is not for use with braces, consult a dentist or orthodontist fitting a brace or other device to the teeth concerning the suitability of this mouthguard, this mouthguard should not be used unless approved by the person fitting the brace.
- For full details of fitting, please see Fitting Instructions overleaf.
- For those whose jaw is still growing, the fitting of the mouthguard should be checked regularly. The mouthguard will need to be replaced if it no longer fits properly.
- Please consult your dental surgeon or orthodontist before use if you intend to use this mouthguard as a night guard.
- This mouthguard is made from FDA grades of TPR and EVA.
- The Box supplied provides secure, clean storage for your mouthguard. The Mouthguard should be kept in the box when not in use. Use fresh water (do not exceed 35°C/95°F) to wash both mouthguard and case after each use. Dry thoroughly before storage.
- This Kyro Pro Mouthguard is for the sole use of _____ From the following date / /
- Dependent upon the regularity and severity of use, Makura Sport recommends that your mouthguard should be replaced every 2 years, however you must visually check your mouthguard after each use. If the biting surface is worn, cracked or split the mouthguard should be replaced immediately.
- If the mouthguard causes sensitization or allergic reaction, or if you experience discomfort after wearing your mouthguard, medical attention should be sought immediately.
- This Type 2 mouth-adapted mouthguard has been tested and certified by SATRA Technology Centre Ltd, Wyndham Way, Telford Way Industrial Estate Kettering, Northamptonshire NN 16 8SD, United Kingdom (Notified Body Number 0521).



This mouthguard does not contain Latex. The materials used are not currently known to cause allergic reactions or sensitization.



REV #
17.10

Makura Sport Ltd, Lakeside, Fountain Lane, St Mellons, Cardiff CF3 0FB UK
MAKURASPORT.COM

BATCH #

FITTING INSTRUCTIONS

- 1 There is no boiling or custom fitting required with this Lithos Pro mouthguard. Place mouthguard in your mouth and carefully fit over the fixed braces ensuring the braces align with the Ortho Channel. This mouthguard will fit securely and comfortably when properly positioned.

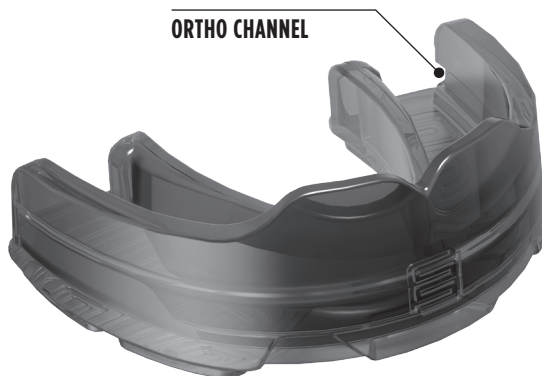

- 2 Take care when removing mouthguard so as not to dislodge braces.
- 3 This Lithos Pro mouthguard does not require any 'finishing', i.e. no trimming is permitted to assist with fit and comfort.

Do not throw this leaflet away as it contains information that is important to the user.

WARNING!

Please ensure that you have read and fully understood the following safety precautions and user guide before using this mouthguard:

This mouthguard is suitable for use with braces, consult a dentist or orthodontist fitting a brace or other device to the teeth concerning the suitability of this mouthguard, this mouthguard should not be used unless approved by the person fitting the brace.

DO NOT chew your mouthguard.

If your mouthguard is chewed and/or is not used as intended, then its effectiveness in terms of fit, protection and durability will be greatly reduced. Please carefully follow the fitting instructions overleaf. The intended user of this Lithos Pro mouthguard must ensure that they add their name to the label located inside the mouthguard box and in the area provided below in the Mouthguard User Guide.

This Mouthguard must not be used by any person other than the named person detailed in the Mouthguard User Guide and on the Mouthguard Box

For wearers whose jaw is still in growth, primary dentition exfoliation and secondary dentition eruption, the fit of the mouthguard must be checked regularly by a responsible guardian. If the mouthguard is found to be loose or tight fitting, to the teeth or gums, it must be replaced.

MOUTHGUARD USER GUIDE

- **This mouthguard is suitable for use with braces, consult a dentist or orthodontist fitting a brace or other device to the teeth concerning the suitability of this mouthguard, this mouthguard should not be used unless approved by the person fitting the brace.**
- This packaging contains important information and must be retained for future reference.
- This Lithos Pro (Ready-Made Type Mouthguard) has passed DD 253: 2001 and achieved Performance Level 2 impact tests for people playing lesser contact sports and recreations such as Baseball, Basketball, Cricket, Football, Hockey, Lacrosse, Martial Arts, Rugby and other contact sports.
- There are two levels of the Impact Performance Level allocated to DD 253: 2001 approved Mouthguards, namely 1 and 2, where Level 1 offers the lowest level of protection and Level 2 offers the highest level of protection.
- When choosing a mouthguard please select a mouthguard of appropriate size and type based on the age range information provided by the manufacturer. Please ensure that the mouthguard you have chosen is of the correct type and performance level related to the sport and recreation that you will be using the mouthguard for. A list of all the sporting activities that this mouthguard is intended to be suitable for is provided.
- For full details of fitting, please see Fitting Instructions overleaf.
- For those whose jaw is still growing, the fitting of the mouthguard should be checked regularly. The mouthguard will need to be replaced if it no longer fits properly.
- Please consult your dental surgeon or orthodontist before use if you intend to use this mouthguard as a night guard.
- This mouthguard is made from a medical grade Silicone Rubber.
- The Box supplied provides secure, clean storage for your mouthguard. The Mouthguard should be kept in the box when not in use. Use fresh water (do not exceed 35°C/95°F) to wash both mouthguard and case after each use. Dry thoroughly before storage.
- This Lithos Pro Mouthguard is for the sole use of _____ From the following date / /
- Dependent upon the regularity and severity of use, Makura Sport recommends that your mouthguard should be replaced every 2 years, however you must visually check your mouthguard after each use. If the biting surface is worn, cracked or split the mouthguard should be replaced immediately.
- If the mouthguard causes sensitization or allergic reaction, or if you experience discomfort after wearing your mouthguard, medical attention should be sought immediately.
- This Ready-Made Type mouthguard has been tested and certified by SATRA Technology Centre Ltd, Wyndham Way, Telford Way Industrial Estate, Kettering, Northamptonshire NN 16 8SD, United Kingdom (Notified Body Number 0321).

This mouthguard does not contain Latex. The materials used are not currently known to cause allergic reactions or sensitization.

FITTING INSTRUCTIONS

You will need: 1 pan filled with 3cm water, 1 slotted spoon, 1 cup of iced water, 1 mirror and a timer.



BRING TO BOIL

1 Bring the pan of water to the boil.



CAUTION! HOT WATER
ADULTS ONLY

2 Place mouthguard in the pan for 50 seconds.



COOL OFF

3 Remove mouthguard from the water to cool off for 90 seconds.



FIT TO UPPER TEETH

4 Looking in the mirror, fit the mouthguard onto upper teeth, biting down firmly.



SUCKING & PRESSING CENTRE

5 Suck in and press the centre of the mouthguard.

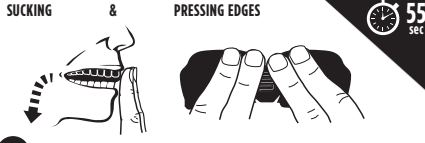

SUCKING & PRESSING EDGES

6 Suck in and press the edges of the mouthguard.



ICED WATER

7 Take the mouthguard out of your mouth and place it in to the iced water.

- 8** Place the mouthguard in the mouth and test for a secure, comfortable fit.
- 9** If mouthguard does not fit comfortably, or does not stay in place **A** a suitably-fitted mouthguard should withstand hanging a 100g weight off it for at least 30 seconds without falling out), allow a few minutes to rest before repeating procedures 1-7 (procedures 5 and 6 are the most important steps).
- 10** Only if necessary, **B** carefully use a pair of scissors to trim off small pieces.

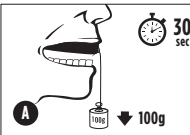

A

30 sec

100g



B

SCISSORS ONLY

30 sec

Do not throw this leaflet away as it contains information that is important to the user.

WARNING!

Please ensure that you have read and fully understood the following safety precautions and user guide before using this mouthguard:

This mouthguard is not for use with braces. DO NOT chew your mouthguard.

To ensure that your mouthguard functions correctly it is essential that it is adjusted to fit your teeth and gums properly. If your mouthguard is chewed and/or is not used as intended, then its effectiveness in terms of fit, protection and durability will be greatly reduced. Please carefully follow the fitting instructions overleaf. The intended user of this Tephra Max mouthguard must ensure that they add their name to the label located inside the mouthguard box and in the area provided below in the Mouthguard User Guide.

This Mouthguard must not be used by any person other than the named person detailed in the Mouthguard User Guide and on the Mouthguard Box.

As per Item 3 of the Fitting Instructions overleaf, please ensure that the Mouthguard has cooled sufficiently (90 seconds) prior to placing the Mouthguard in your mouth.

For wearers whose jaw is still in growth, primary dentition exfoliation and secondary dentition eruption, the fit of the mouthguard must be checked regularly by a responsible guardian. If the mouthguard is found to be loose or tight fitting, to the teeth or gums, it must be replaced.

MOUTHGUARD USER GUIDE

- This packaging contains important information and must be retained for future reference.
- This Tephra Max (Type 2 Mouth - Adapted Mouthguard) has passed SATRA Document M33:2011 – Issue 3, Performance Level 3 impact tests for people playing lesser contact sports and recreations such as Baseball, Basketball, Cricket, Football, Hockey, Lacrosse, Martial Arts, Rugby and other contact sports.
- There are three levels of the Impact Performance Level allocated to Mouthguards, namely 1, 2 and 3, where Level 1 offers the lowest level of protection and Level 3 offers the highest level of protection.
- When choosing a mouthguard please select a mouthguard of appropriate size and type based on the age range information provided by the manufacturer. Please ensure that the mouthguard you have chosen is of the correct type and performance level related to the sport and recreation that you will be using the mouthguard for. A list of all the sporting activities that this mouthguard is intended to be suitable for is provided.
- This mouthguard is not for use with braces, consult a dentist or orthodontist fitting a brace or other device to the teeth concerning the suitability of this mouthguard, this mouthguard should not be used unless approved by the person fitting the brace.
- For full details of fitting, please see Fitting Instructions overleaf.
- For those whose jaw is still growing, the fitting of the mouthguard should be checked regularly. The mouthguard will need to be replaced if it no longer fits properly.
- Please consult your dental surgeon or orthodontist before use if you intend to use this mouthguard as a night guard.
- This mouthguard is made from FDA grades of TPR and EVA.
- The Box supplied provides secure, clean storage for your mouthguard. The Mouthguard should be kept in the box when not in use. Use fresh water (do not exceed 35°C/95°F) to wash both mouthguard and case after each use. Dry thoroughly before storage.
- This Tephra Max Mouthguard is for the sole use of _____ From the following date / /
- Dependent upon the regularity and severity of use, Makura Sport recommends that your mouthguard should be replaced every 2 years, however you must visually check your mouthguard after each use. If the biting surface is worn, cracked or split the mouthguard should be replaced immediately.
- If the mouthguard causes sensitization or allergic reaction, or if you experience discomfort after wearing your mouthguard, medical attention should be sought immediately.
- This Type 2 mouth-adapted mouthguard has been tested and certified by SATRA Technology Centre Ltd, Wyndham Way, Telford Way Industrial Estate Kettering, Northamptonshire NN 16 8SD, United Kingdom (Notified Body Number 0321).



This mouthguard does not contain Latex. The materials used are not currently known to cause allergic reactions or sensitization.

FITTING INSTRUCTIONS

You will need: 1 pan filled with 3cm water, 1 slotted spoon, 1 cup of iced water, 1 mirror and a timer.

1 Bring the pan of water to the boil

2 Place mouthguard in the pan for 12 seconds

CAUTION! HOT WATER
ADULTS ONLY

3 Remove mouthguard from the water to cool off

COOL OFF

4 Looking in the mirror, fit the mouthguard onto upper teeth, biting down firmly

FIT TO UPPER TEETH

BITE DOWN FIRMLY

5 Suck in and press the centre of the mouthguard

SUCKING & PRESSING CENTRE

6 Suck in and press the edges of the mouthguard

SUCKING & PRESSING EDGES

7 Take the mouthguard out of your mouth and place it in to the iced water

ICED WATER

8 Place the mouthguard in the mouth and test for a secure, comfortable fit.

9 If mouthguard does not fit comfortably, or does not stay in place **A** a suitably-fitted mouthguard should withstand hanging a 100g weight off it for at least 30 seconds without falling out), allow a few minutes to rest before repeating procedures 1-7 (procedures 5 and 6 are the most important steps).

A

30 sec

100g

10 Only if necessary, **B** carefully use a pair of scissors to trim off small pieces.

B

SCISSORS ONLY

Do not throw this leaflet away as it contains information that is important to the user

WARNING!

Please ensure that you have read and fully understood the following safety precautions and user guide before using this mouthguard:

This mouthguard is not for use with braces. DO NOT chew your mouthguard.

To ensure that your mouthguard functions correctly it is essential that it is adjusted to fit your teeth and gums properly. If your mouthguard is chewed and/or is not used as intended, then its effectiveness in terms of fit, protection and durability will be greatly reduced. Please carefully follow the fitting instructions overleaf. The intended user of this Toka Pro mouthguard must ensure that they add their name to the label located inside the mouthguard box and in the area provided below in the Mouthguard User Guide.

This Mouthguard must not be used by any person other than the named person detailed in the Mouthguard User Guide and on the Mouthguard Box.

As per Item 3 of the Fitting Instructions overleaf, please ensure that the Mouthguard has cooled sufficiently (30 seconds) prior to placing the Mouthguard in your mouth.

For wearers whose jaw is still in growth, primary dentition exfoliation and secondary dentition eruption, the fit of the mouthguard must be checked regularly by a responsible guardian. If the mouthguard is found to be loose or tight fitting, to the teeth or gums, it must be replaced.

MOUTHGUARD USER GUIDE

- This packaging contains important information and must be retained for future reference.
- This Toka Pro (Type 2 Mouth - Adapted Mouthguard) has passed SATRA Document M33:2011 – Issue 3, Performance Level 2 impact tests for people playing lesser contact sports and recreations such as Baseball, Basketball, Cricket, Football, Hockey, Lacrosse, Martial Arts, Rugby and other contact sports.
- There are three levels of the Impact Performance Level allocated to Mouthguards, namely 1, 2 and 3, where Level 1 offers the lowest level of protection and Level 3 offers the highest level of protection.
- When choosing a mouthguard please select a mouthguard of appropriate size and type based on the age range information provided by the manufacturer. Please ensure that the mouthguard you have chosen is of the correct type and performance level related to the sport and recreation that you will be using the mouthguard for. A list of all the sporting activities that this mouthguard is intended to be suitable for is provided.
- This mouthguard is not for use with braces, consult a dentist or orthodontist fitting a brace or other device to the teeth concerning the suitability of this mouthguard, this mouthguard should not be used unless approved by the person fitting the brace.
- For full details of fitting, please see Fitting Instructions overleaf.
- For those whose jaw is still growing, the fitting of the mouthguard should be checked regularly. The mouthguard will need to be replaced if it no longer fits properly.
- Please consult your dental surgeon or orthodontist before use if you intend to use this mouthguard as a night guard.
- This mouthguard is made from FDA grades of TPR and EVA.
- The Box supplied provides secure, clean storage for your mouthguard. The Mouthguard should be kept in the box when not in use. Use fresh water (do not exceed 35°C/95°F) to wash both mouthguard and case after each use. Dry thoroughly before storage.
- This Toka Pro Mouthguard is for the sole use of _____ From the following date / /
- Dependent upon the regularity and severity of use, Makura Sport recommends that your mouthguard should be replaced every 2 years, however you must visually check your mouthguard after each use. If the biting surface is worn, cracked or split the mouthguard should be replaced immediately.
- If the mouthguard causes sensitization or allergic reaction, or if you experience discomfort after wearing your mouthguard, medical attention should be sought immediately.
- This Type 2 mouth-adapted mouthguard has been tested and certified by SATRA Technology Centre Ltd, Wyndham Way, Telford Way Industrial Estate Kettering, Northamptonshire NN 16 8SD, United Kingdom (Notified Body Number 0321).



This mouthguard does not contain Latex. The materials used are not currently known to cause allergic reactions or sensitization.